

LOGO
SEE NOTE 5.

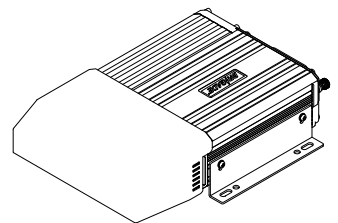

Revision Notes.				
R1 - NAME UPDATED TO ALLOW FOR 3G AND WIFI MODELS. TABLES ADDED TO INDICATE VARIOUS SYSTEMS.				
APA: E.PANG	Drawn:L.PILLAY	Checked:R.BATES	Approved:B.JOHN	Date: 17/11/2015
R2 - CHANGE TO STANDARD FMW AND 3G Wi-Fi FMW. CHANGE TO MCU VERSION.				
APA: E.Pang	Drawn:L.Pillay	Checked:M.Potter	Approved: B.Childs	Date: 21/01/2016
R3 - ADDED UPSUFFIXED PART NUMBER FOR CD (CR-A4.12). REVISED BRACKET DESCRIPTION				
APA: E.Pang	Drawn:L.Pillay	Checked:M.Butler	Approved:D.Wallin	Date: 25/02/2016
R4 - MCU FW CHANGE FROM T512303 TO T608181 AS PER ECR- A459.				
APA: E.PANG 29/09/16	Drawn:W.BEAZLEY	Checked:L.PILLAY	Approved:D.WALLIN	Date: 29/09/16
R5 - FMW CHANGE FROM T5C2301(STD) AND T5C04.11(3G/Wi-Fi) TO T692980 AS PER ECR-A427.				
APA: S. ZHANG	Drawn:L.PILLAY	Checked:R. BATES	Approved:B. CHILDS	Date: 19/10/2016

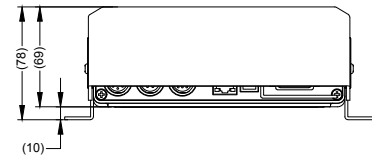
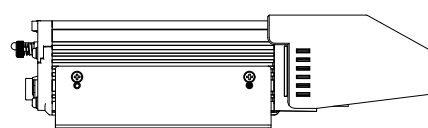
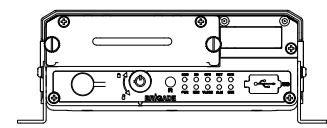
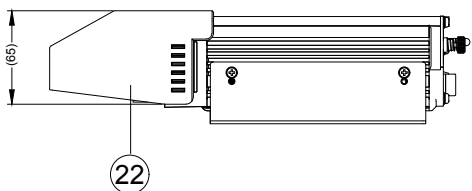
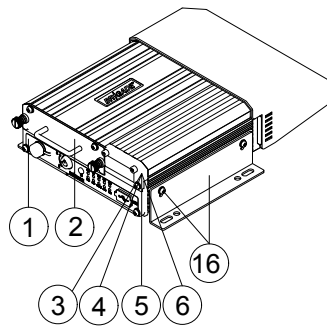

ITEM	PART NUMBER	QTY	MODEL NUMBER	DESCRIPTION
(A)	4869	1	MDR-408-1000	8 CHANNEL MOBILE DIGITAL RECORDER WITH 1000GB HDD, GPS & 64GB SD CARD
(B)	4944	1	MDR-408GW-1000	8 CHANNEL MOBILE DIGITAL RECORDER WITH 1000GB HDD, GPS, 3G, Wi-Fi & 64GB SD CARD
(C)	4942	1	MDR-408G-1000	8 CHANNEL MOBILE DIGITAL RECORDER WITH 1000GB HDD, GPS, 3G & 64GB SD CARD
(D)	4943	1	MDR-408W-1000	8 CHANNEL MOBILE DIGITAL RECORDER WITH 1000GB HDD, GPS, Wi-Fi & 64GB SD CARD

- NOTES:
1. REFERENCE INSTRUCTION MANUAL FOR FUNCTIONALITY.
 2. FOR PRODUCT LABEL REFER TO LATEST REVISION OF DRAWING: BE-003110-XX-15.
 3. FOR GIFTBOX LABEL REFER TO LATEST REVISION OF DRAWING: BE-003111-XX-15.
 4. FOR SERIAL NUMBER LABEL REFER TO LATEST REVISION OF DRAWING: BE-003112-XX-15.
 5. FOR COMPONENT DETAILS REFER TO COMPONENT DRAWINGS.
 6. ANY CUSTOMER MODIFICATION OF THIS PRODUCT CAUSING SUBSEQUENT FAILURE IS NOT A LIABILITY OF BRIGADE ELECTRONICS GROUP PLC.
 7. FIXING SCREWS SUPPLIED IN CLEAR PLASTIC BAG.
 8. FOR BRIGADE LOGO SEE BRIGADE-LARGE-LOGO STICKER 55185-4526(01.10.05.218)-V1.0.
 9. VARIOUS SYSTEM OPTIONS A, B, C OR D CONTAIN RELEVANT COMPONENTS.

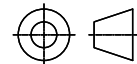
PROPRIETARY NOTICE
THIS DESIGN AND TECHNICAL INFORMATION APPEARING ON THIS DRAWING IS THE PROPERTY OF BRIGADE ELECTRONICS, AND IS DISCLOSED IN CONFIDENCE. IT IS NOT TO BE COPIED, REPRODUCED, REVEALED TO OR EXPROPRIATED BY OTHERS, EITHER IN WHOLE OR IN PART WITHOUT THE EXPRESS WRITTEN CONSENT OF BRIGADE ELECTRONICS.

Sheet No 1 of 2	Assembly Pl Approval E.PANG	Approved by B.JOHN	Checked by M.BUTLER	Drawn by L.PILLAY
	Angle of Projection  Third Angle	Units mm	Scale N/A	Released 21/07/15
 www.brigade-electronics.com		Status RELEASED	MDR-408XX-1000	
		Part No Various	BE-003092-05-15	

Revision Notes.				
R1 - NAME UPDATED TO ALLOW FOR 3G AND WIFI MODELS. TABLES ADDED TO INDICATE VARIOUS SYSTEMS.				
APA: E.PANG	Drawn:L.PILLAY	Checked:R.BATES	Approved:B.JOHN	Date: 17/11/2015
R2 - CHANGE TO STANDARD FMW AND 3G Wi-Fi FMW. CHANGE TO MCU VERSION.				
APA: E.Pang	Drawn:L.Pillay	Checked:M.Potter	Approved:B.Childs	Date: 21/01/2016
R3 - ADDED UPSUFFIXED PART NUMBER FOR CD (CR-A4.12). REVISED BRACKET DESCRIPTION				
APA: E.Pang	Drawn:L.Pillay	Checked:M.Butler	Approved:D.Wallin	Date: 25/02/2016
R4 - MCU FW CHANGE FROM T512303 TO T608181 AS PER ECR- A459.				
APA: E.PANG 29/09/16	Drawn:W.BEAZLEY	Checked:L.PILLAY	Approved:D.WALLIN	Date: 29/09/16
R5 - FMW CHANGE FROM T5C2301(STD) AND T5C04.11(3G/Wi-Fi) TO T692980 AS PER ECR-A427.				
APA: S. ZHANG	Drawn:L.PILLAY	Checked:R.BATES	Approved:B.CHILDS	Date: 19/10/2016

ITEM	PART NUMBER	QTY	MODEL NUMBER	DESCRIPTION	MCU VERSION	FIRMWARE VERSION
(A)	4869	1	MDR-408-1000	8 CHANNEL MOBILE DIGITAL RECORDER WITH 1TB HDD, GPS & 64GB SD CARD	T608181	T692980
(B)	4944	1	MDR-408GW-1000	8 CHANNEL MOBILE DIGITAL RECORDER WITH 1TB HDD, GPS, 3G, Wi-Fi & 64GB SD CARD	T608181	T692980
(C)	4942	1	MDR-408G-1000	8 CHANNEL MOBILE DIGITAL RECORDER WITH 1TB HDD, GPS, 3G & 64GB SD CARD	T608181	T692980
(D)	4943	1	MDR-408W-1000	8 CHANNEL MOBILE DIGITAL RECORDER WITH 1TB HDD, GPS, Wi-Fi & 64GB SD CARD	T608181	T692980

R5

ITEM	①	②	③	④	⑤	⑥	⑦	⑧	⑨	⑩
DESCRIPTION	MAIN RECORDER UNIT	HDD CADDY AND 1TB	EXPANSION MODULE WITH GPS, 3G, Wi-Fi, G-SENSOR AND 64GB SD CARD	EXPANSION MODULE WITH GPS, 3G, G-SENSOR AND 64GB SD CARD	EXPANSION MODULE WITH GPS, G-SENSOR AND 64GB SD CARD	STANDARD EXPANSION MODULE WITH GPS, Wi-Fi G-SENSOR AND 64GB SD CARD	MDR 408 26 PIN TRIGGER AND EIA/TIA 485 CABLE LOOM (NOT SHOWN)	MDR 400 SERIES 9-PIN POWER CABLE (NOT SHOWN)	MDR 400 SERIES 10 TO 4 PIN VIDEO OUTPUT CABLE (NOT SHOWN)	MDR 408 VIDEO INPUT CABLE LOOM (NOT SHOWN)
MODEL NUMBER	MDR-408-DS	MDR-408-1000-MCU	MDR-408GW-EXP	MDR-408G-EXP	MDR-408W-EXP	MDR-408-EXP	MDR-408-TRIG	MDR-400-PC	MDR-400-VOC	MDR-408-VIC
PART NUMBER	4898	4900	5000	5001	5002	4899	4882	4878	4879	4880
MDR-408-1000 QTY	1	1			1		1	1	1	1
MDR-408GW-1000 QTY	1		1				1	1	1	1
MDR-408G-1000 QTY	1	1		1			1	1	1	1
MDR-408W-1000 QTY	1	1			1	1	1	1	1	1

ITEM	⑪	⑫	⑬	⑭	⑮	⑯	⑰	⑱	⑲	⑳	㉑	㉒
DESCRIPTION	MDR 400 SERIES GPS ANTENNA (NOT SHOWN)	MDR 400 SERIES 3G ANTENNA (NOT SHOWN)	MDR 400 SERIES Wi-Fi ANTENNA (NOT SHOWN)	MDR 400 SERIES USB A TO B CABLE (NOT SHOWN)	SECURITY KEY (NOT SHOWN)	2X BRACKET WITH 4X M4X8 FIXING SCREWS	REMOTE CONTROL WITH 2xAAA BATTERIES (NOT SHOWN)	INSTALLATION GUIDE (NOT SHOWN)	3G AND Wi-Fi INSTALLATION GUIDE (NOT SHOWN)	INSTALLATION CD (NOT SHOWN)	3G AND Wi-Fi INSTALLATION CD (NOT SHOWN)	BACK SHIELD
MODEL NUMBER	MDR-400-GPS	MDR-ANT-3G-01	MDR-ANT-Wi-Fi-01	MDR-400-USB-B	MDR-400-KEY	MDR-400-BKT	MDR-400-RC	MDR-400-IG	MDR-400W-IG	MDR-400-CD	MDR-400W-CD	MDR-408-BKS
PART NUMBER	4883	4989	4990	4884	4891	4892	4893	4894	5018	4995B	5014	4923
MDR-408-1000 QTY	1			1	1	1	1	1		1		1
MDR-408GW-1000 QTY	1	1	1	1	1	1	1	1	1		1	1
MDR-408G-1000 QTY	1	1		1	1	1	1	1	1		1	1
MDR-408W-1000 QTY	1		1	1	1	1	1	1	1		1	1

NOTES:

1. REFERENCE INSTRUCTION MANUAL FOR FUNCTIONALITY.
2. FOR PRODUCT LABEL REFER TO LATEST REVISION OF DRAWING: BE-003110-XX-15.
3. FOR GIFTBOX LABEL REFER TO LATEST REVISION OF DRAWING: BE-003111-XX-15.
4. FOR SERIAL NUMBER LABEL REFER TO LATEST REVISION OF DRAWING: BE-003112-XX-15.
5. FOR COMPONENT DETAILS REFER TO COMPONENT DRAWINGS.
6. ANY CUSTOMER MODIFICATION OF THIS PRODUCT CAUSING SUBSEQUENT FAILURE IS NOT A LIABILITY OF BRIGADE ELECTRONICS GROUP PLC.
7. FIXING SCREWS SUPPLIED IN CLEAR PLASTIC BAG.
8. FOR BRIGADE LOGO SEE BRIGADE-LARGE-LOGO STICKER 55185-4526(01.10.05.218)-V1.0.
9. VARIOUS SYSTEM OPTIONS A, B, C OR D CONTAIN RELEVANT COMPONENTS.

PROPRIETARY NOTICE

THIS DESIGN AND TECHNICAL INFORMATION APPEARING ON THIS DRAWING IS THE PROPERTY OF BRIGADE ELECTRONICS, AND IS DISCLOSED IN CONFIDENCE. IT IS NOT TO BE COPIED, REPRODUCED, REVEALED TO OR EXPROPRIATED BY OTHERS, EITHER IN WHOLE OR IN PART WITHOUT THE EXPRESS WRITTEN CONSENT OF BRIGADE ELECTRONICS.

Sheet No
2 of 2

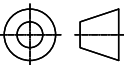
Assembly Pl Approval E.PANG	Approved by B.JOHN	Checked by M.BUTLER	Drawn by L.PILLAY
Angle of Projection	Units mm	Scale N/A	Released 21/07/15
 Third Angle	Status RELEASED	MDR-408XX-1000	
	Part No Various	BE-003092-05-15	

BRIGADE[®]
www.brigade-electronics.com